



**MARINETECH
PRODUCTS, INC.**

Safe-Skeg



Tel: 651-486-2010
Fax: 651-486-6989
E-mail: info@marinotech.info

PART NUMBER: 35-SS690

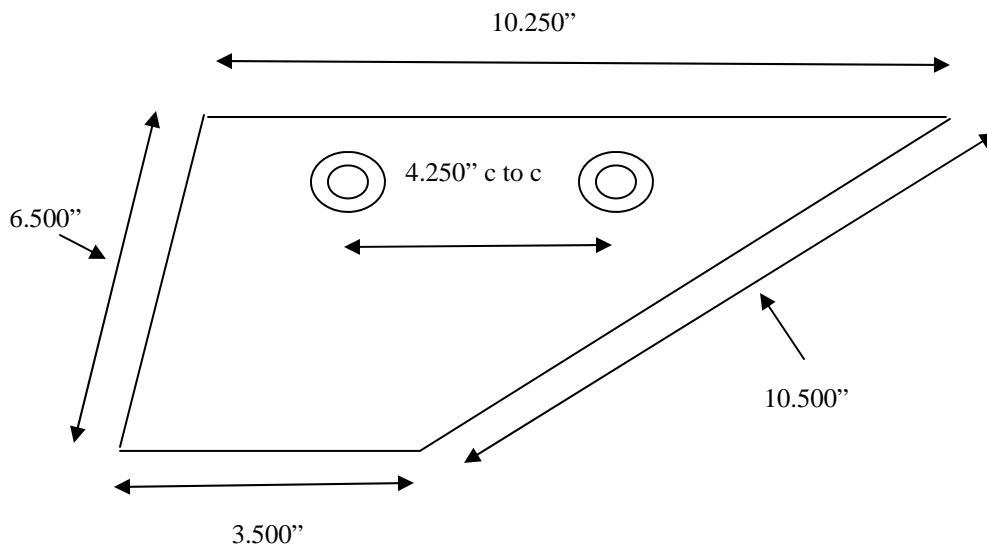

Made of 316 Marine Grade SS
1.5mm material thickness

Typical thickness of skeg
.625"