



# MODEL 55-0045

MOTOR LIFT



## INSTALLATION AND OPERATING INSTRUCTION

For outboards up to 35HP weighing up to 263 pounds.  
This motor lift is designed for clamp screw type outboards only.

**651.486.2010**  
MARINETECH PRODUCTS, INC  
1360 East County Road E  
VADNAIS HEIGHTS, MN 55110  
[www.marinetechproducts.com](http://www.marinetechproducts.com)

REV 12/15  
99-55288

# INTRODUCTION

Congratulations, you have just purchased one of the finest auxiliary outboard motor lifts available today. With proper installation and care, this motor lift will provide you with years of trouble free use and performance.

Please take a few moments to review the information contained in this booklet to familiarize yourself with the installation procedures suggested to successfully mount your new motor lift. Installation is easy particularly when you know each step ahead of time.

**BEFORE USING YOUR MOTOR LIFT READ THE OPERATING TIPS (PG. 10) FOR PRECAUTIONS WHEN USING YOUR MOTOR LIFT ON THE WATER AND WHEN TRAILERING YOUR BOAT**

## ***MOTOR LIFT OWNER'S MANUAL***

**Warning!** Completely read and understand these instructions before attempting to install and use this motor lift. Harm to you and damage to your boat could occur if you do not follow these directions. Safety precautions should be adhered to when removing and installing the motor to install this motor lift.

- If you have questions and feel that you can not properly install this motor lift ... **STOP** immediately and call us at 651-486-2010.

Failure to follow these instructions exactly could result in permanent damage to your hydraulic pump.

- **DO NOT** connect large red and black cables from the pump relay harness to the battery until all other installations are complete.

If you encounter problems after installation is complete, please refer to our “Troubleshooting” section in the back of the manual.

If you have questions call 651-486-2010.

**KEEP THIS MANUAL WITH THE BOAT FOR FUTURE REFERENCE.**

## MAINTENANCE

To keep motor lift operating properly, follow all maintenance procedures in this manual.

- Maintain fluid level to bottom of fill plug on engine side of pump reservoir.
- Before each and every use, check the mounting bolts at motor plate engine side and transom side.

# GETTING STARTED

Here is a Parts List followed by a list of the tools, equipment, hardware & supplies that you will need:

## PARTS LIST

- [1] Motor Lift
- [2] Pump relay harness
- [3] Relays (2)
- [4] Rocker switch assembly with wiring harness
- [5] Spacer Block (Shim)
- [6] Manual
- [7] Safety Cable

## Tools and Equipment:

1. Electric drill with 1/8, 3/16, 3/8 and 1/2 inch drill bits
2. Two 3/4 inch wrenches
3. A Phillips head screw driver
4. For heavier motors, a hoist to lift the motor while installing the bracket

## Hardware and Supplies: (not included)

- 4 – 1/2 inch diameter stainless steel Hex Cap Screws of the appropriate length\*\*\*
- 4- 1/2 inch stainless steel Nylon insert nuts
- 8 – 1/2 inch stainless steel flat washers
- 1 – Tube of clear RTV silicon for sealing the transom mounting holes (recommended)
- 1 – Tube of dielectric grease for the electrical connections (recommended)
- 2 – Security bolts that match the clamp bracket on your motor (recommended)

\*\*\* For proper bolt length selection see the information on the following page. \*\*\*

**CAUTION!** On the hydraulic motor, **DO NOT** make an electrical connection to the boat's battery until all of the following steps are followed and you are instructed to do so in section (Making Electrical Connections). Failure to follow these instructions could result in an electrical short or damage to the hydraulic motor and/or boat components.

# **BEFORE STARTING**

## **Selecting the Mounting position**

The Panther Model 45 Motor Lift is designed so that the motor must be mounted near or at the top of the transom. The unit should be mounted so that the prop will have sufficient depth when the motor is lowered into the water. Once you have selected the best mounting position, be sure to check inside the transom to make sure that there is adequate clearance for the bolts and nuts and that the transom is sufficiently reinforced for mounting the bracket.

## **How to measure for transom mounting bolts**

Because each transom is different, you will need to determine the right length of mounting bolts. For installations where mounting holes will be drilled, you can take this measurement after the holes have been drilled. Simply measure the thickness of the transom and add 2 inches.

## **Make sure motor hoses and cables are long enough for set back**

This motor lift bracket places your outboard several inches farther away from the controls, battery and gas tank. Check to make sure that each of these cables and hoses has the required amount of slack. An easy way to check this is to unclamp the outboard from the boat and secure it to an engine hoist. Simply move the motor hoist back several inches with all of the hoses and cables still connected. If it can be moved so that there is adequate slack in the cables, the motor lift will work.

## **MOUNTING THE MOTOR LIFT BRACKET**

1. Hold the bracket in the selected location on the transom. Check to make sure that the hole placement will not interfere with any moldings, rivets, etc.
2. Make sure the bracket is level. Once positioned, use the transom plate as a template and mark two upper and the three lowest holes. The three lowest holes **MUST** be used. The bottom hole must be flat against the mounting surface. The entire lower tab mount must make contact with the boat.
3. Using a 3/16 bit, drill a pilot hole in each location to make sure the holes are properly aligned and that there will be no interference with the mounting bolts. Finish drilling the holes with a 1/2 inch drill bit.
4. Before mounting the unit, apply a bead of RTV silicone sealant around the edge of each hole to insure a watertight seal.
5. To mount the Motor Lift bracket to the transom use five 1/2 inch diameter stainless steel bolts with washers and nylon locking nuts. Start by placing a bolt with a washer into each of the upper mounting holes. Stick a piece of tape over the head of each bolt to hold them in place, then lift the unit up to the transom, align the bolts and slide the unit into place. Install the washers and the nuts inside the boat. Do not tighten the nuts completely until the lower bolts have been installed.
6. Complete the installation by inserting the three lower mounting bolts, together with washer and the nylon locking nuts. Tighten each bolt evenly, taking care not to over torque the nut to the point where the transom or the bracket could be damaged.
7. Do not weld or attach anything to the bracket.

# MOUNTING THE MOTOR

1. Your motor lift bracket is supplied with a plastic 2 X 3 shim to help mount the motor to the bracket.
2. Place the shim on the inside of the motor plate, under the lip, and hold it in place while placing the motor over the top edge of the bracket. Snug the motor clamps against the shim.
3. Attach the electrical components, and slowly run the motor up to a full tilt position to make sure that there is sufficient clearance for the clamp bracket and the clamp handles. Reposition the motor as necessary.
4. Tighten the motor clamps securely. Use cable ties or other means to secure the clamp handles to prevent accidental loosening during operation.
5. Make sure to install the security bolts in the outboards lower clamp brackets. This is very important to prevent the outboard motor from sliding up and off the clamping block. After the motor is clamped to the Panther lift, use the outboards cast in security holes in the lower clamp brackets to guide a 5/16" drill bit through the Panther motor plate, then install the 5/16" bolts, washers, and nyloc nuts to secure the outboard to the Panther motor mount. In some cases a 3/8" bolt may be required.

# ELECTRICAL CONNECTIONS

This unit is designed to operate off of a standard 12 volt battery and is generally connected to the boats main starting battery. The wiring is laid out below for illustration. The motor lift is outside the picture on the top connected by the two bullet connectors.

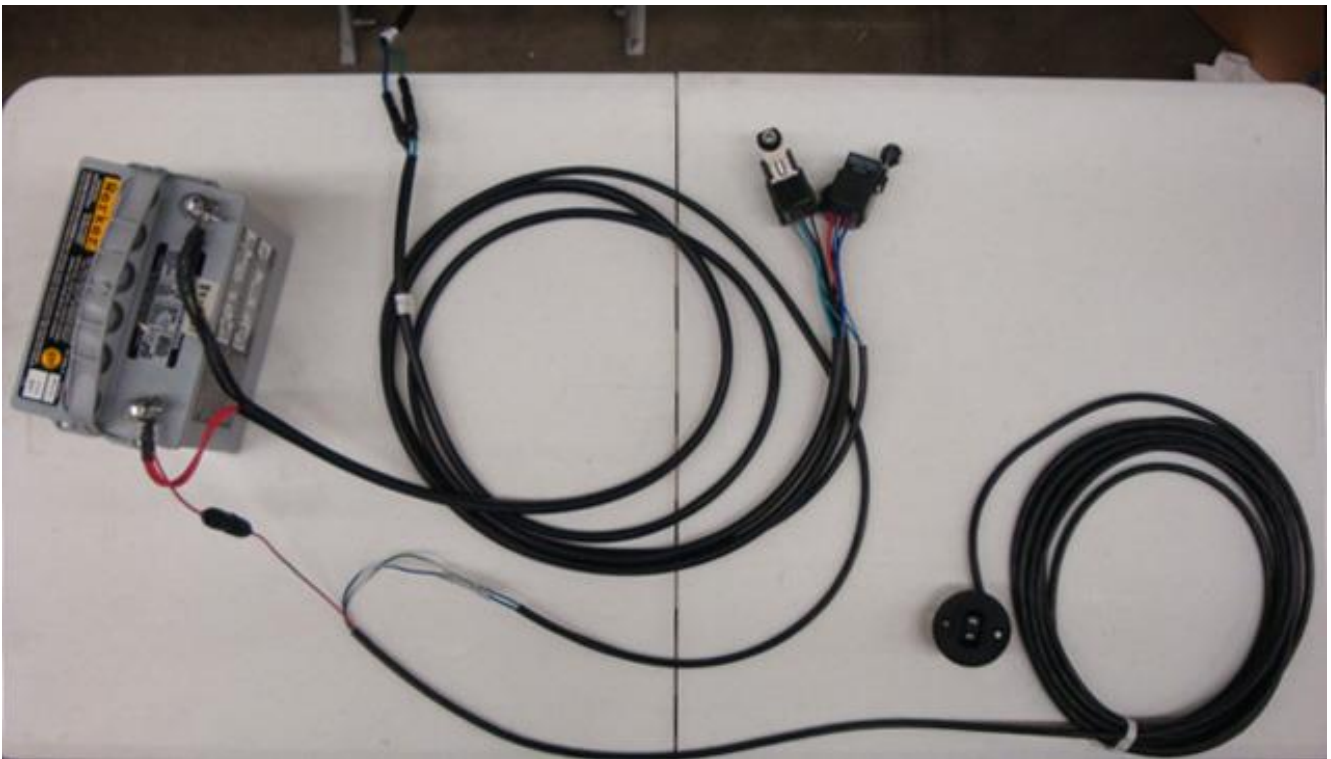

Follow the instructions on the next page:

1. Install the two relays into the two sockets of the main pump relay harness.

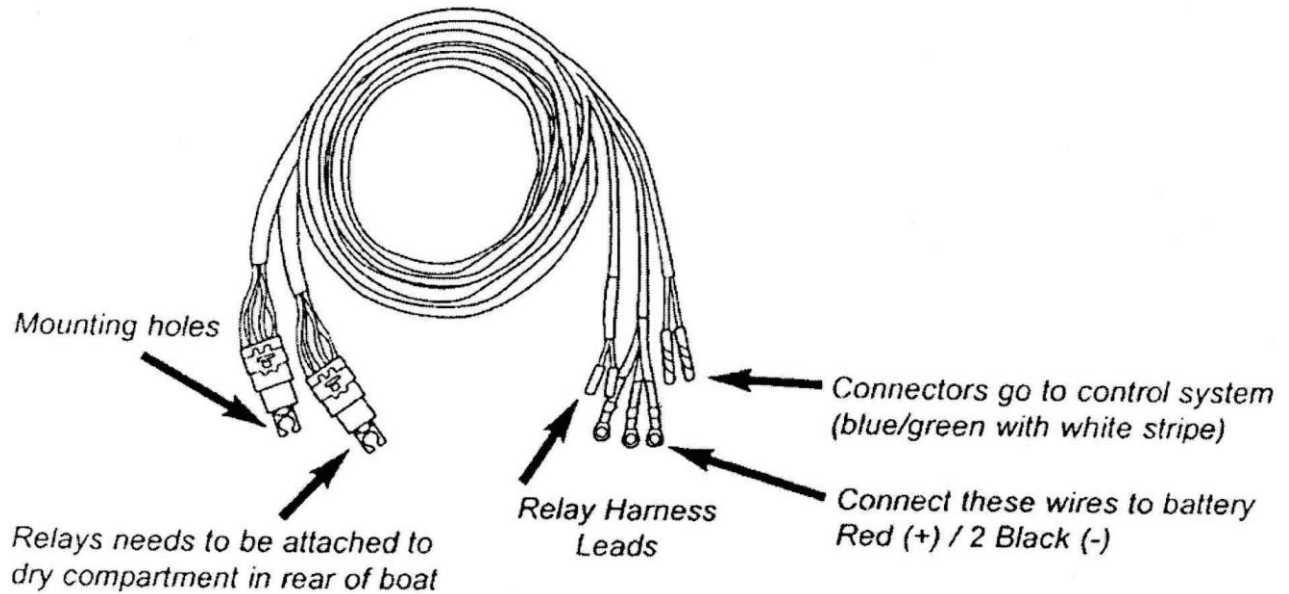

2. Connect blue and green pump motor connectors coming from motor lift to blue and green connectors of relay harness (shown as Relay Harness Leads above). Use a small amount of dielectric grease with each of the connectors and plug them together. (It is also recommended that these connections be wrapped with a waterproof tape or shrink tube.
3. Connect the blue/white stripe and green/white strip connectors to the blue/white stripe and green/white strip connectors of the rocker switch (control system) wiring harness assembly.
4. Connect the two Black ring terminal wires from the relay harness to the negative (-) terminal of the 12V Battery. Connect the two remaining Red ring terminal wires to the positive (+) terminal of the 12V Battery.
5. Test the unit by running it up and down to make sure that there is adequate slack in the leads. Connect the red lead to the positive (+) terminal and the black lead to the negative (-) terminal.
6. If the unit runs satisfactorily, disconnect the battery terminal wires and begin mounting the rocker switch and relay harness per the steps outlined below.

## MOUNTING THE RELAY HARNESS

**WARNING!** Do not connect relay harness to battery until entire assembly and controls are mounted and ready. Severe damage to pump and controls could occur.

- A. Find suitable place to mount relay harness. A dry place, typically the rear compartment is recommended.
- B. Mount relay harness using mounting holes located on relay harness bracket. Drill holes and bolt relay harness securely in place.

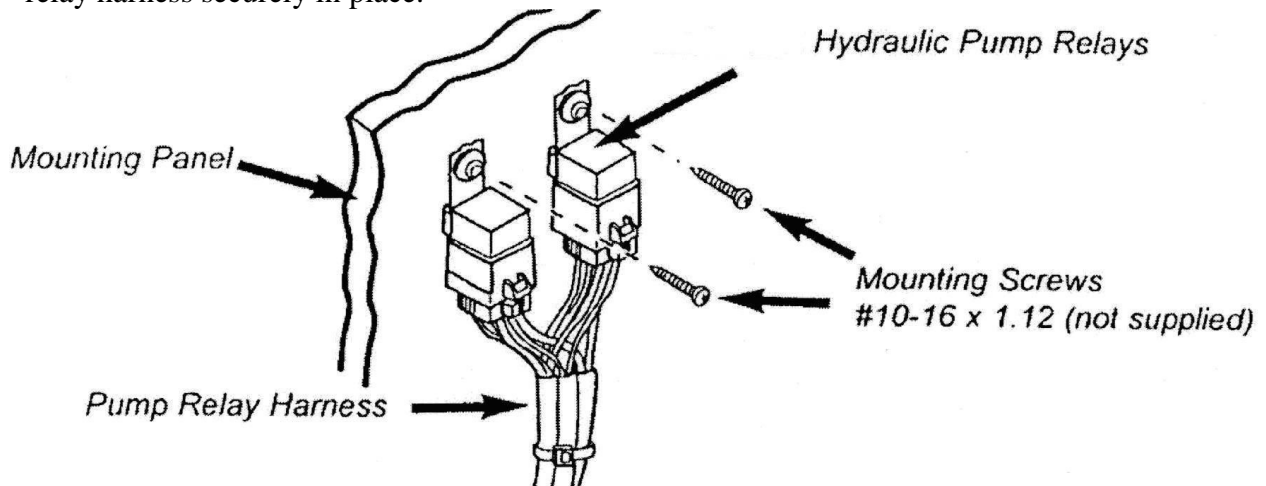

**WARNING!** When drilling the holes, **BE SURE** not to drill through the hull or side wall.

## INSTALLATION OF ROCKER CONTROL SWITCH

**CAUTION!** Before cutting any holes in mounting surface check area behind mounting surface for obstructions. (Cable braces, wiring, etc.)

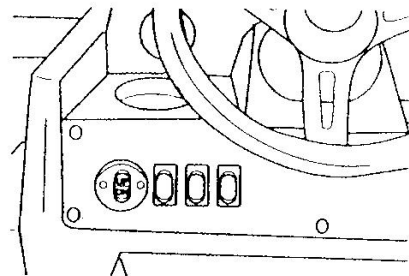

### DRILLING TIPS:

If mounting surface is fiberglass, apply masking tape to the surface that is to be cut to prevent mounting surface from chipping or cracking. If the mounting surface is vinyl covered, remove the vinyl from the surface to be cut using a razor blade to keep vinyl from tearing.

**NOTE:** The toggle control switch can be flush mounted or surface mounted depending on location chosen. In either case, the toggle control switch should be positioned within easy reach of the boats operator and within reach of the motor lift pump relay harness.

## FLUSH MOUNTING ROCKER CONTROL SWITCH

**NOTE:** Mounting surface must be a minimum of 1/16<sup>th</sup> inches (1.6 mm) or a maximum of 1/2". (12.7 mm) thick for toggle control switch assembly to tighten securely.

1. Using a 2-1/8<sup>th</sup> inch (54 mm) hole saw, drill out marked area of mounting surface.
2. Route toggle control switch harness through bezel retainer.

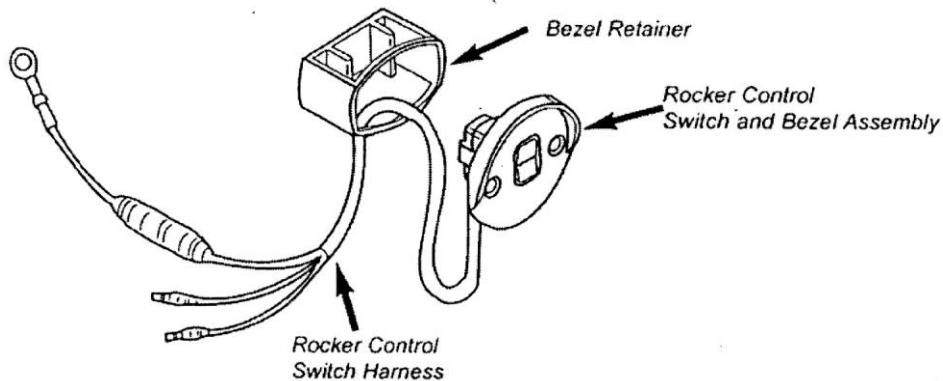

**NOTE:** The bezel retainer is mounted onto the switch bezel before placement into opening. A gap between the bezel and the bezel retainer must be 1/8" (3.2 mm) greater than the thickness of the mounting surface.

3. Attach the bezel retainer to bezel using (2) screws.
4. Install switch harness through mounting surface. **NOTE:** Install into position by placing pressure on screw heads to maintain a gap between bezel retainer and bezel. Push the assembly into the opening and then tighten screws securely.

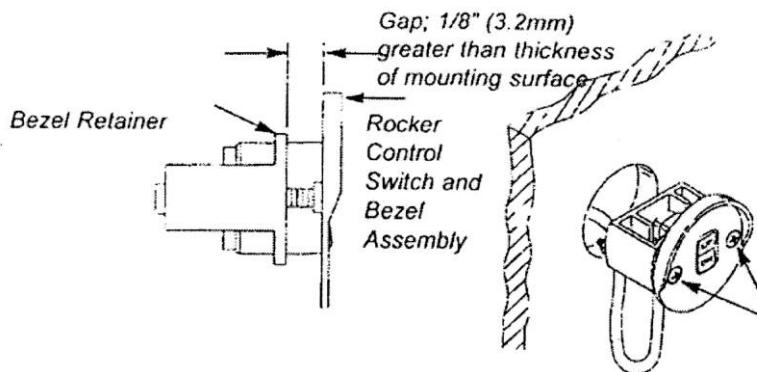

Screws 10-32 x 2 1/4"



## **SURFACE MOUNT ROCKER CONTROL SWITCH**

1. Route toggle control switch harness through surface mounting adapter.
2. Mark and drill pilot holes in the mounting surface using 3/31” (2.4mm) drill bit. Route wiring harness through notch in mounting adapter. Secure switch assembly to mounting surface with self tapping screws as shown. Tighten securely.

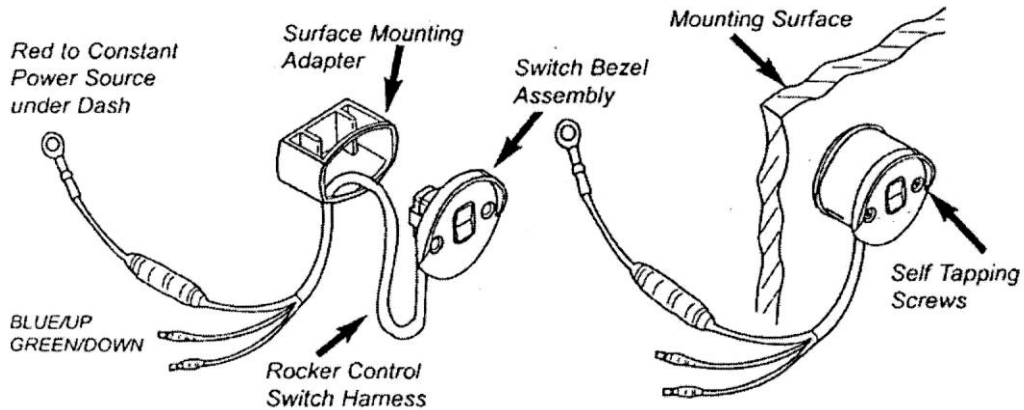

## **CONNECT RELAY HARNESS POWER CABLES TO CRANK BATTERY**

- A Attach large red and black leads from relay harness to crank battery.  
Red to positive (+) -----Black to negative (-)

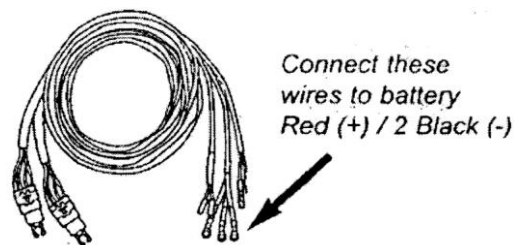

## **HYDRAULIC MOTOR LIFT LUBRICATION**

**CAUTION!** The oil in the motor lift hydraulic system is under pressure when the jack plate is in any position other than fully elevated (“UP”), or the hydraulic ram fully extended. Open the yellow fill cap only when hydraulic ram has been fully extended.

1. Cycle the Motor Lift several times from the full down to full up position.
2. With Motor Lift in the “Full-up” (hydraulic, ram fully extended) position, slowly remove yellow fill cap and check hydraulic fluid level. If needed, fill to the bottom of threads in oil reservoir. (Use Power Trim and Steering Fluid or Dextron III ATF Fluid.)

**WARNING!** Personal injury or boat damage could occur if interference exists using the motor lift. Carefully check to make sure that the motor lift and outboard components have adequate clearance in all operation modes.

**IMPORTANT!** Check clearance of all mounting hardware after installation and before water testing.

## **MOTOR LIFT CLEARANCE TESTS**

1. Test the outboard trim with the motor lift half way down. NOTE: The propeller must be “UP” so it does not hit the ground
2. If the outboard is equipped with a trim limit switch, make sure that when the outboard is tilted all the way up, the steering system components do not come in contact with the motor lift.
3. With the motor lift half way down, trim the outboard upward and turn the steering wheel side to side. Make sure the outboard motor does not contact the motor lift, transom, or steering components.
4. Repeat the above test with the motor lift in the full down position. If you have interference, **DO NOT WATER TEST THE BOAT!** Unbolt the outboard and raise to the next set of mounting holes or install a trim limit switch to ensure no interferences. If changes were necessary, retest clearances. NOTE: After motor lift installation and prior to operating boat, determine the outboard engines required water pressure. This information may be found in the outboard owner’s operation manual or service manual. If the boat is not equipped with a water pressure gauge, it is recommended that one be installed prior to using a motor lift.

**CAUTION!** Damage to outboard will occur if proper water pressure is not maintained. Raising the outboard too high will result in a water pressure drop and overheating of the outboard will occur. Proper water pressure must be maintained at all times during operation of the outboard.

**NOTE:** After determining proper operating height, again check for proper outboard clearances.

## **ADDITIONAL SAFETY ITEMS**



When using the motor lift on open water, attach the included **Outdoor Motor Safety Cable** (see picture on left—part #55-0415) to the boat and motor lift. This is a vinyl coated 3/32” diameter, 50” long heavy duty steel cable with one loop and one snap hook.

## **IMPORTANT NOTE:**

**Trailing with the motor on the lift is NOT RECOMMENDED. MarineTech Products will not be held responsible for damages or injuries incurred when trailing with the motor attached to the 55-0045 motor lift.**

## **TROUBLE SHOOTING**

### **PROBLEM**

### **POSSIBLE SOLUTIONS:**

- |  |  |
|--|--|
| 1. Motor Lift groans or chatters when operating      | <ol style="list-style-type: none"><li>a. Cycle motor lift up and down six to eight times. If noise continues follow steps b and c.</li><li>b. Be certain your battery is sufficiently charged to power the electric motor properly.</li><li>c. Turn to page 9 and follow lubrication procedures. You may need to cycle the motor lift several times to work the grease into the bushings.</li><li>d. Turn to page 9 and follow the procedure for adding hydraulic fluid to the pump reservoir. You may need to cycle the motor lift several times to work the air out of the system.</li></ol>   |
| 2. Motor lift will not go up or down.                | <ol style="list-style-type: none"><li>a. Check to be sure your key switch is on.</li><li>b. Check to make sure your battery has a sufficient charge.</li><li>c. Check 20 amp fuse attached to Rocker Control Switch (certain models).</li><li>d. Check power connection at the key switch to be sure you have proper (+) and (-) connections.</li><li>e. Check hydraulic pump and motor power connection at the battery.</li><li>f. Check all wire connections and connectors.</li><li>g. Check to make sure the relays are making proper contact.</li><li>h. Check for boat circuit breakers or fuses that may have been tripped.</li><li>i. If motor runs but motor lift does not move: see <b>trouble shooting section 5</b>.</li></ol> |
| 3. Motor runs but motor lift does not move.          | <ol style="list-style-type: none"><li>a. Check hydraulic hose connections to be sure they are tight (do not over tighten).</li><li>b. Check hydraulic fluid level, see page 9 for filling instructions. You may need to cycle the motor lift several times to work the air out of the system.</li></ol>  |
| 4. Motor lift motor and pump makes a gurgling sound. | <p>Check hydraulic fluid level, see page 9 for filling instructions. You may need to cycle the jack plate several times to work the air out of the system.</p>   |

5. Motor Lift goes in the the wrong direction when operated: Check the blue and green wires to be sure they are connected to the same color termination points. Reversing these wires will cause the motor lift to operate in the wrong direction.
6. Prop is cavitating.
- Adjust motor plate setting down, you may be running your engine too high.
  - Check to be sure your prop has not been damaged.
  - Check to be sure your trim has not been set too high.
  - Check for obstructions to water flowing from your boat hull to your engine lower unit such as speedometer pick up, depth sounding transducers and water surface temperature pick ups. All such items if located improperly can cause aeration of the water which can result in prop cavitations.
7. Motor lift binds.
- Check tightness of all bolts and screws. Tighten any bolts or screws that are loose. Check periodically if problem persists and remove bolts and add red permanent Loc-Tite, reinsert bolt or screw and tighten. If significant damage has occurred to the motor lift structure, contact the manufacturer.
  - Turn to page 6 and follow lubrication procedures. You may need to cycle the motor lift several times to work the grease into the bushings.
  - Check for foreign objects lodged in your motor lift. **Never run motor lift with hands close to motor lift!**
  - Check hydraulic fluid level; see page 9 for filling instructions. You may need to cycle the motor lift several times to work the air out of the system.
8. Motor Lift dead
- Check fuse—a 10 Amp fuse is located at the end of the rocker switch cable near the red (+) terminal of the battery.
  - Check to be sure that all connectors are making proper contact and are not corroded.
  - Check battery condition – is the battery fully charged.
  - Check for electrical shorts or opens. A short should cause the fuse to blow. An open will cause it not to operate, but will not blow the fuse.
9. Motor Lift stops running intermittently
- Check wires for intermittent open (an open may occur do to vibration).
  - Check relays for proper contact or corrosion.
  - Check wire termination points for proper contact.

# AVAILABLE ACCESSORIES

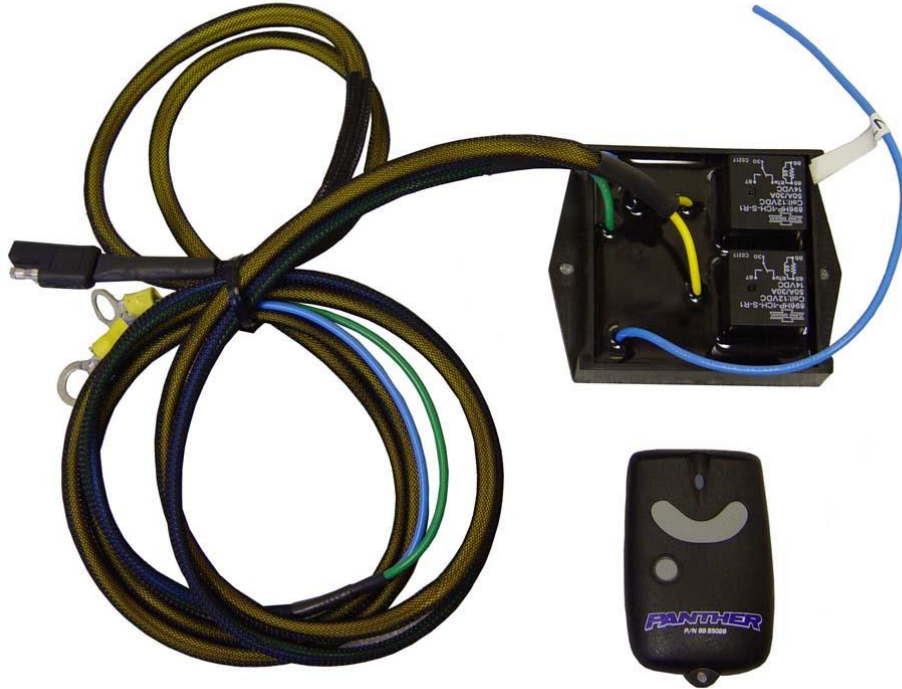

## Wireless Remote

**55-0105\*** (\*Ask for required special adaptor wire P/N 99-0045 pictured below)



Control your motor lift from anywhere within the boat without the hassle of tripping over wires. 50ft operating range. Powered from a standard A23 - 12V battery. Can be used on any Panther Trim and Tilt unit or any product that has a two prong molded connector. Enhance the performance of your Panther Products and especially the 55-0045 Motor Lift by going wireless.

**WARNING: Never operate the wireless remote from outside the boat.**

**Wireless Installation:** (see picture on Page 14)

- 1) Remove rocker switch assembly (leave the pump relay harness attached to pump).
- 2) Locate adapter cord. It is the two wire red/black cable with the two prong molded connector on one end and two bullet connectors on the opposite end.
- 3) Plug the two prong molded connector into cord coming directly from wireless receiver unit.
- 4) Attach the other end of the adaptor cord to the pump relay harness cable. The red wire from the wireless receiver unit plugs into the green wire of the pump relay harness. The black wire from the wireless receiver plugs into the blue wire on the pump harness relay.
- 5) Attach the red ring terminal to the (+) Positive post on the 12V Boat Battery.
- 6) Attach the black ring terminal to the (-) Negative post on the 12V Boat Battery.



## **WIRELESS REMOTE TROUBLE SHOOTING**

### **Weak Signal:**

1. **Battery may be low.** To replace battery, remove the screw on the back of the transmitter. Remove the back cover carefully, noticing how the rubber membrane is seated in the case. Remove and replace the battery. Reinstall back cover making sure that the rubber membrane is seated in the case. Install screw and carefully tighten. ***Do not over tighten.*** Dispose of old battery properly. During periods of long inactivity, it is recommended to remove the battery.
2. **Receiver is obstructed.** Move receiver in a direct line with the transmitter. Make sure antenna is not obstructed.
3. **Programming the transmitter to the receiver.**
  1. Disconnect power to receiver (either positive or negative terminal).
  2. Enable the transmitter by pressing the power button, the LED will flash twice.
  3. Hold down either directional button on the transmitter.
  4. While holding down button connect power for about one second.
  5. You should hear a relay on the receiver “click”.
  6. Release button and fully reconnect power.
  7. Your transmitter is now programmed to the receiver.





## SERVICE AND WARRANTY

Should your unit ever require service, *please do not return the product to your dealer*. Please call the number below for special instructions on shipping and handling. Please call between 9:00 am - 3:00 pm (Central Standard/Daylight Time) Monday through Friday. If service is required and covered by warranty, it will be repaired or replaced as described below. If service is required and not covered by warranty (such as damage caused from improper trailering), replacement parts are available for purchase and may be paid for by credit card.

**The warranty coverage on this equipment is limited to the terms set forth below:**

MarineTech warrants this product to be free of defects in material and workmanship for a period of THREE (3) YEARS from the date of original retail purchase on the hydraulics and structural members of the plate; and ONE (1) YEAR from the date of original retail purchase on the electrical components. **Positive proof of date of purchase is required for warranty service.** If service is required and covered by warranty, the unit will be repaired or replaced with new or factory rebuilt parts at no charge. **Call customer service for an RMA number.** The defective components must be returned to the address specified, with shipping charges prepaid. Be sure to include your RMA #, your name, address, telephone number and a copy of the sales receipt showing the date of original retail purchase. All sales receipts are subject to verification.

This warranty does not apply if the unit has been damaged by accident, abuse, misuse, poor installation or misapplication, or if it has been modified from its original condition, or if any serial number has been removed or defaced or altered. **This warranty does not cover any expense to remove or reinstall the unit or any of its components.** If a returned unit is not covered by warranty, the sender will be notified and given an estimate of the charges to repair or replace the unit, together with the return shipping charges.

**THIS WARRANTY DOES NOT COVER SPECIAL, INCIDENTAL, OR CONSEQUENTIAL DAMAGES RESULTING FROM ANY BREACH OF WARRANTY, OR UNDER ANY OTHER LEGAL THEORY, INCLUDING BUT NOT LIMITED TO DAMAGE TO OR REPLACEMENT OF OTHER EQUIPMENT AND PROPERTY. THE WARRANTY AND REMEDIES SET FORTH ARE EXCLUSIVE AND IN LIEU OF ALL OTHERS, WHETHER ORAL OR WRITTEN, EXPRESS OR IMPLIED. DUE TO THE SPECIAL AND UNIQUE CONDITIONS THAT MAY EXIST IN EACH APPLICATION, THE MANUFACTURER SPECIFICALLY DISCLAIMS ANY AND ALL IMPLIED WARRANTIES OF MERCHANTABILITY AND FITNESS FOR A PARTICULAR PURPOSE. NO DEALER, AGENT OR EMPLOYEE IS AUTHORIZED TO MAKE ANY MODIFICATION, EXTENSION OR ADDITION TO THIS WARRANTY.**

Some states do not allow exclusion of incidental or consequential damages, so the above exclusions may not apply to you. This warranty gives you specific legal rights, and you may also have other legal rights, which may vary from state to state.

### FOR SERVICE

**send an email to - [info@marinetechproducts.com](mailto:info@marinetechproducts.com)**

**651.486.2010**

**MARINETECH PRODUCTS, INC**

1360 East County Road E

VADNAIS HEIGHTS, MN 55110

[www.marinetechnology.com](http://www.marinetechnology.com)

*MarineTech Products, Inc. is proud to offer these lines:*



*SOLUTIONS FOR MOTOR MOUNTING, REMOTE STEERING, TILT & TRIM,  
SHALLOW WATER ANCHORS, AND SECURITY SYSTEMS*



*THE ORIGINAL ENGINE-MOUNTED ELECTRIC TROLLING  
MOTORS—HIGH THRUST WITH WHISPER QUIET EFFICIENCY*



*ROD HOLDERS, TROLLING MOTOR SUPPORTS, AND  
GPS/SONAR MOUNTS*



*AUXILIARY OUTBOARD MOTOR STEER SYSTEMS*



*THROTTLE CONTROL FOR GAS POWERED AUXILIARY MOTORS*

**MARINETECH PRODUCTS, INC.**

1360 East County Road E  
Vadnais Heights, MN 55110  
651-486-2010

[www.marinetechproducts.com](http://www.marinetechproducts.com)